



TOREX®



DIFFERENTIAL PRESSURE GAUGE
DIFFERENZDRUCKWÄCHTER
SIGNALEUR DE PRESSION
SEGNALATORE DI PRESSIONE

IPM400



IPM400

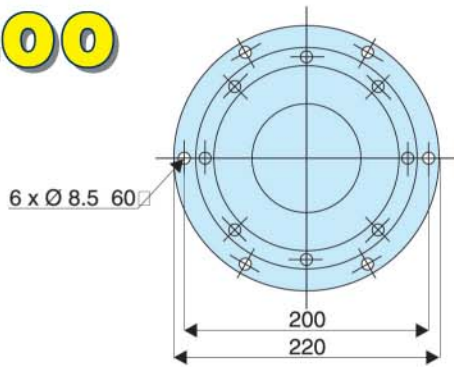

Dimensions in mm

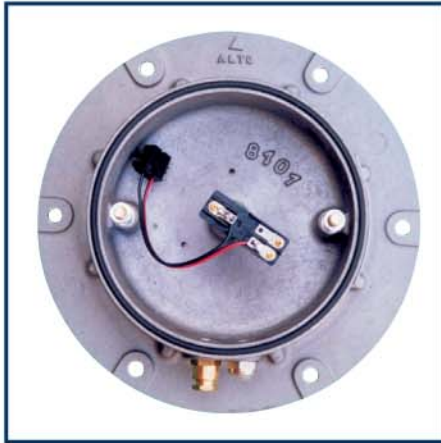
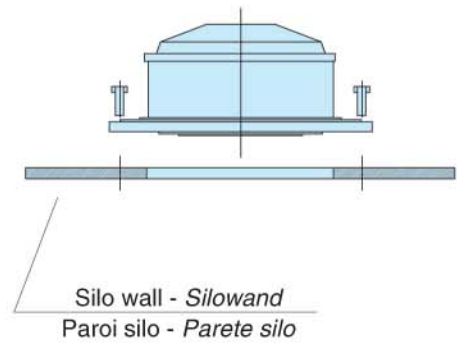
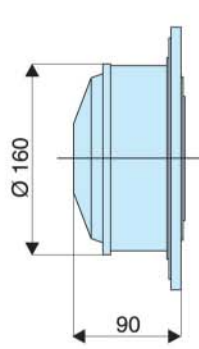

FUNCTION

The silo pressure gauge supervises the overpressure rising inside the silo during the filling procedure and during the purging of the tanker.

DESCRIPTION

- Self-cleaning wear and temperature resistant membrane
- Aluminium alloy body
- Contact switch
- Assembly fittings (bolts and gasket)

FUNKTION

Der Differenzdruckwächter zeigt im Silo auftretenden Überdruck während des Befüllens und während des Endschwalls an.

BESCHREIBUNG

- Selbstreinigende und temperaturwechselbeständige Membran
- Aluminiumgehäuse
- Mikroschalter
- Schrauben und Dichtungen für den Einbau

TECHNICAL FEATURES

- Working temperature: -30°C to +80°C
- Cable size: 2 x 1.5 mm²
- Electromechanical contacts: 15 A / 250 V
- Protection: IP55
- Pre-set activating pressure: 400 mm H₂O = 0.04 bar
- Power consumption: 0.5 W

ASSEMBLY

Installed on top of the IPX spigot.

TECHNISCHE DATEN

- Betriebstemperatur: -30° bis +80°C
- Anschlusskabel: 2 x 1,5 mm²
- Elektrische Kontakte: 15 A / 250 V
- Schutzart: IP55
- Voreingestellter Ansprechdruck: 400 mm H₂O = 0,04 bar
- Energieverbrauch: 0,5 W

EINBAU

Wird auf IPX-Stutzen montiert.

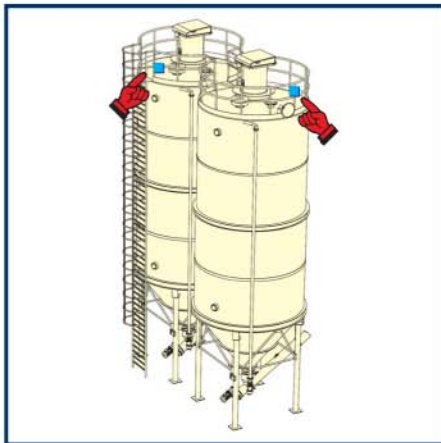

UTILISATION

Le signaleur a pour but d'avertir le dépassement de la pression d'étalonnage de l'instrument lui-même durant le chargement pneumatique du silo.

DESCRIPTION

- Membrane résistante aux écarts de température et autonettoyante.
- Corps en aluminium.
- Microrupteur.
- Boulons et garnitures pour le montage.

UTILIZZO

L'indicatore ha lo scopo di avvertire l'eventuale superamento della pressione di taratura dello strumento stesso.

DESCRIZIONE

- Membrana resistente all'escursione termica e autopulente
- Corpo in alluminio
- Microinterruttore
- Bulloni e guarnizioni per il montaggio

CARACTÉRISTIQUES TECHNIQUES

- Température de service: de -30°C à +80°C
- Câble de liaison électrique: 2 x 1,5 mm²
- Contacts électriques: 15 A / 250 V
- Protection: IP55
- Pression de tarage: 400 mm H₂O = 0,04 bar
- Consommation d'énergie: 0,5 W

MONTAGE

Il est installé sur l'embout de remplissage IPX.

CARATTERISTICHE TECNICHE

- Temperatura di esercizio: da -30°C a +80°C
- Cavo di collegamento elettrico: 2 x 1,5 mm²
- Contatti elettrici: 15A / 250V
- Protezione: IP55
- Pressione di taratura: 400 mm H₂O = 0.04 bar
- Consumo energia: 0.5 W

MONTAGGIO

Viene installato per mezzo del tronchetto IPX.

RANGE OF PRODUCTS
LIEFERPROGRAMM
PRODUCTION
PRODUZIONE

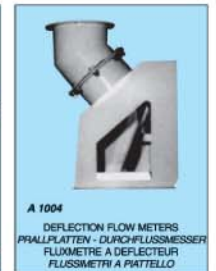
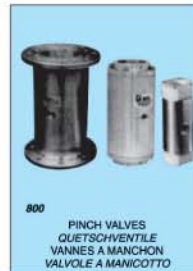
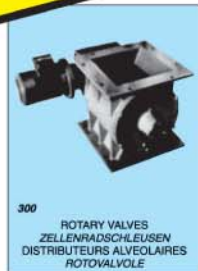

N.B.: Rights reserved to modify technical specifications.

N.B.: Angaben ohne Gewähr. Änderungen können ohne Vorankündigung vorgenommen werden.

N.B.: Toutes données portées dans le présent catalogue n'engagent pas le fabricant. Elles peuvent être modifiées à tout moment.

N.B.: Tutti i dati riportati nel presente catalogo non sono impegnativi e possono subire variazioni in qualsiasi momento.

TOR.940

06.03



TOREX S.r.l.
Via Canaletto, 139/a
I - 41030 S. Prospero s/S. (MO)
ITALY

+39 / 059 / 80 80 811
fax +39 / 059 / 90 82 04
e-mail torex@torex.it
internet www.torex.it